

F-1	1531	395	16	x1	1/1
F-2	1531	395	16	x1	1/1
F-3	352	394	16	x1	1/1
F-4	352	394	16	x1	1/1
F-5	352	347	16	x1	1/1
F-6	352	347	16	x1	1/1
F-7	482	335	16	x1	1/1
F-8	496	346	18	x1	1/1
F-9	496	346	16	x1	1/1
F-10	1512	366	3	x1	1/1

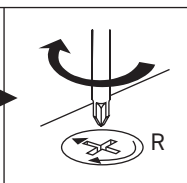

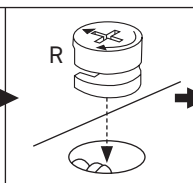

1

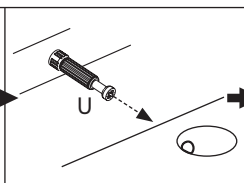
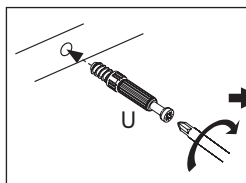
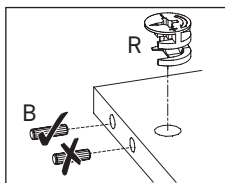
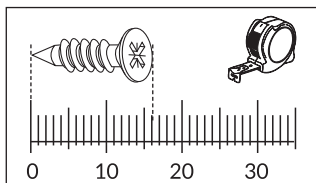
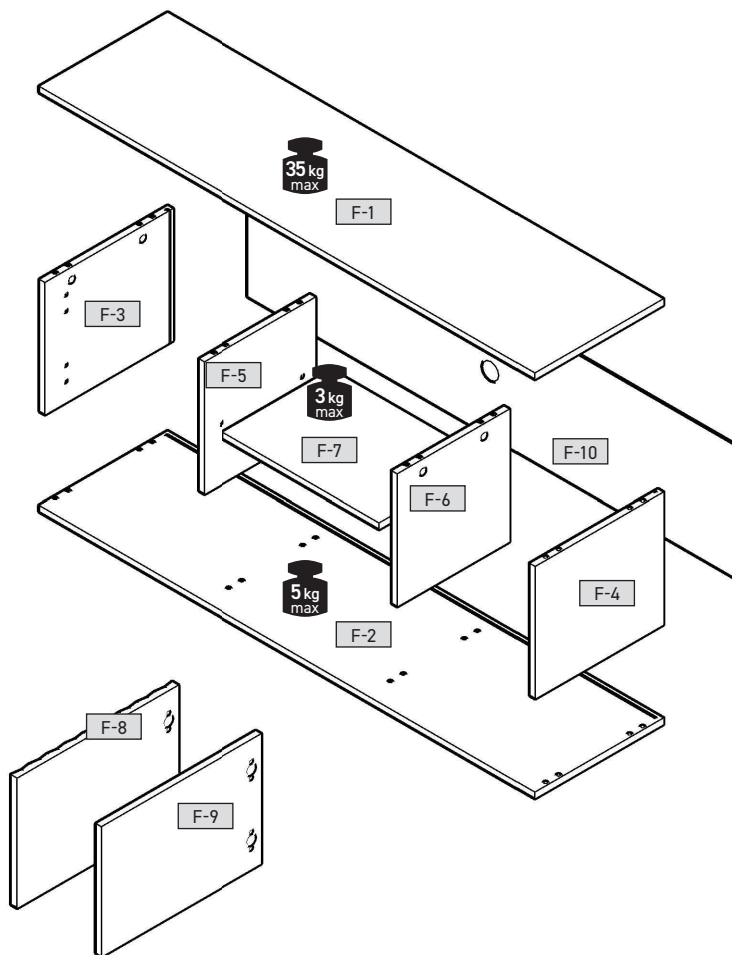
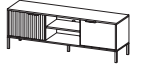
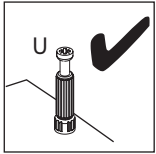
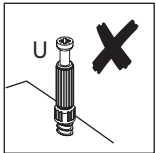
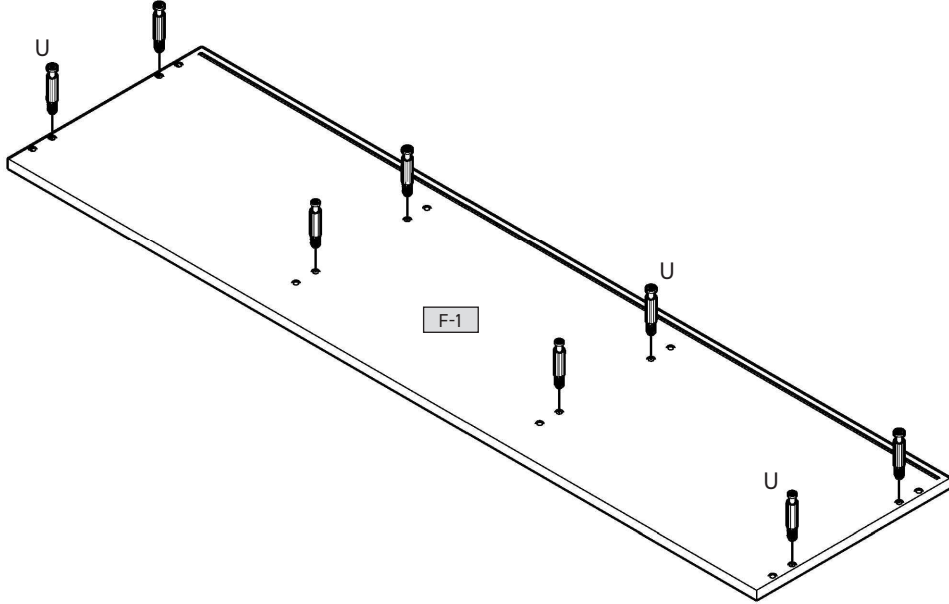
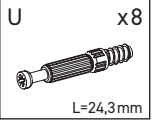

2

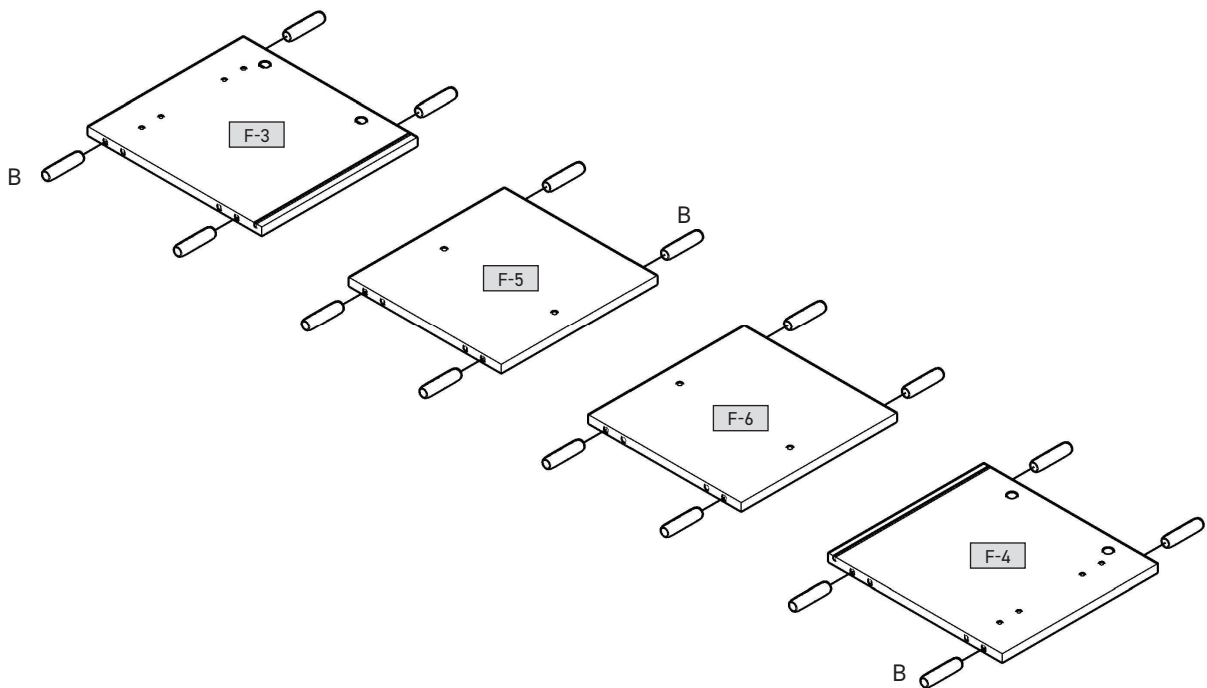
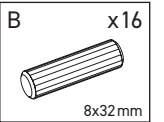

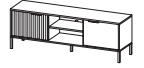

3

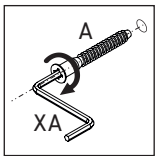
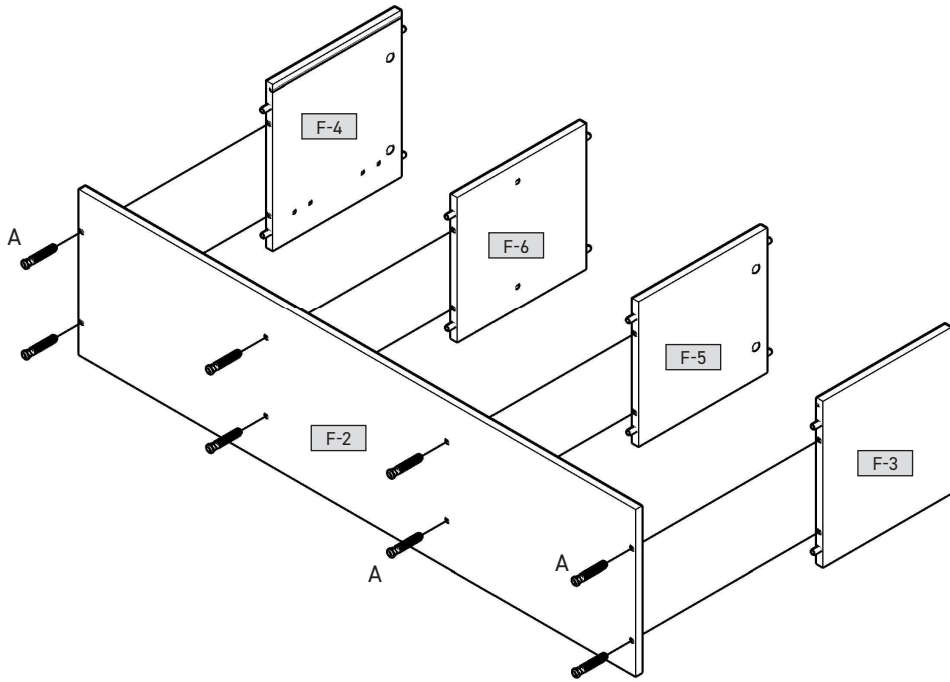
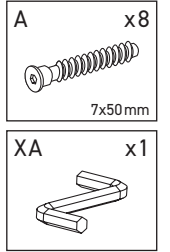

4

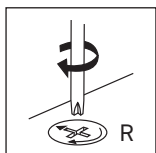
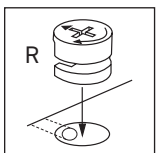
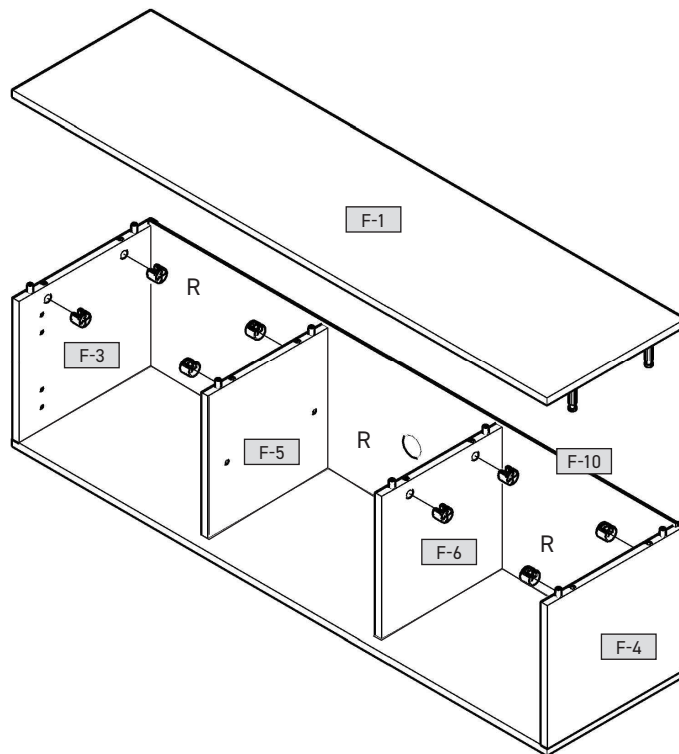
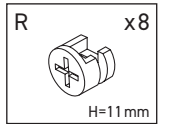

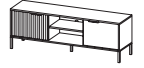

5

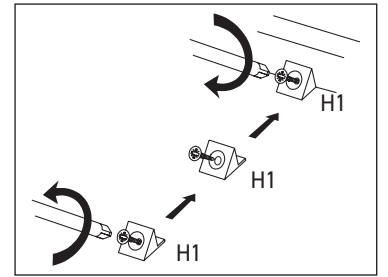
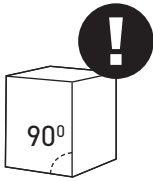
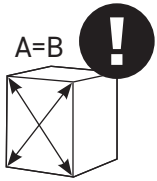
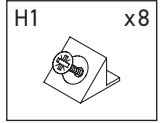
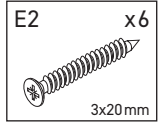
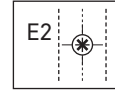
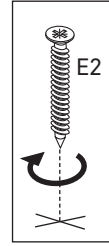
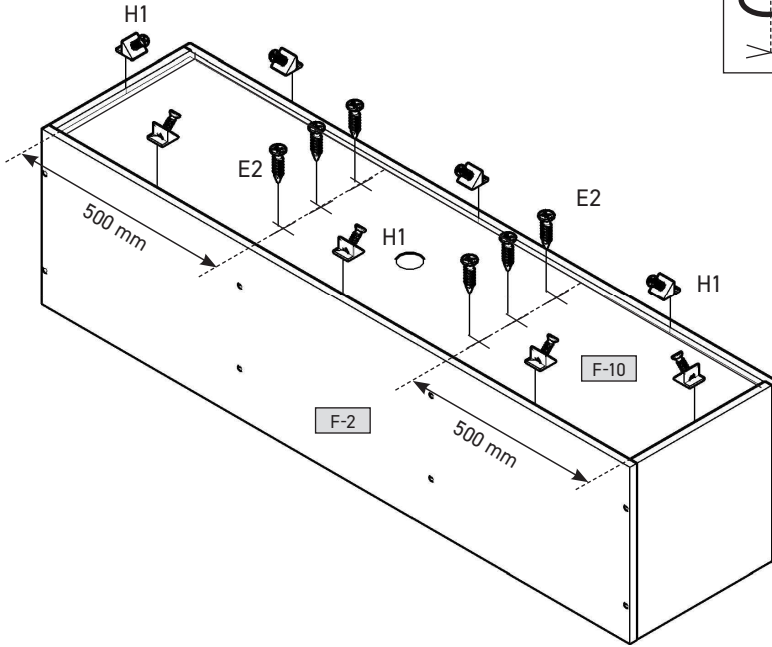

6

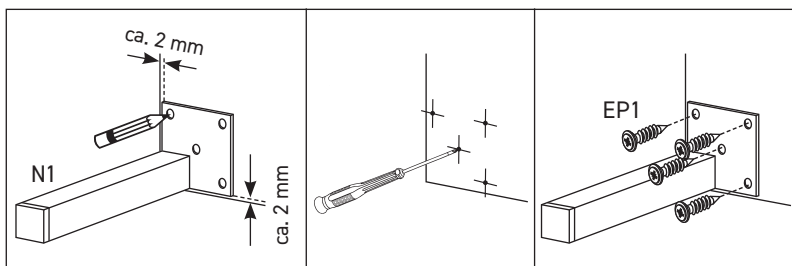
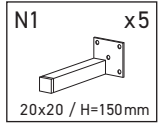
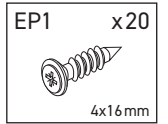
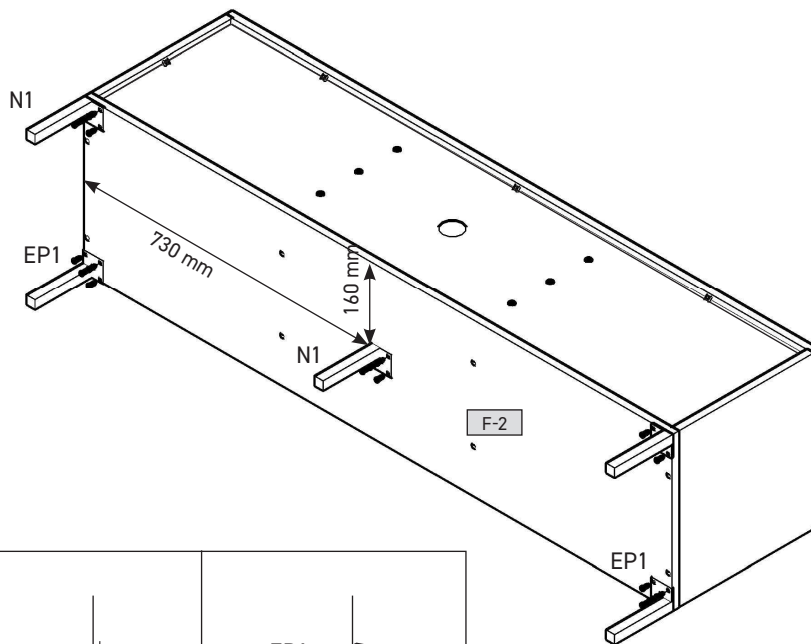

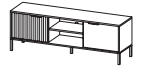

7

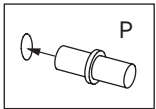
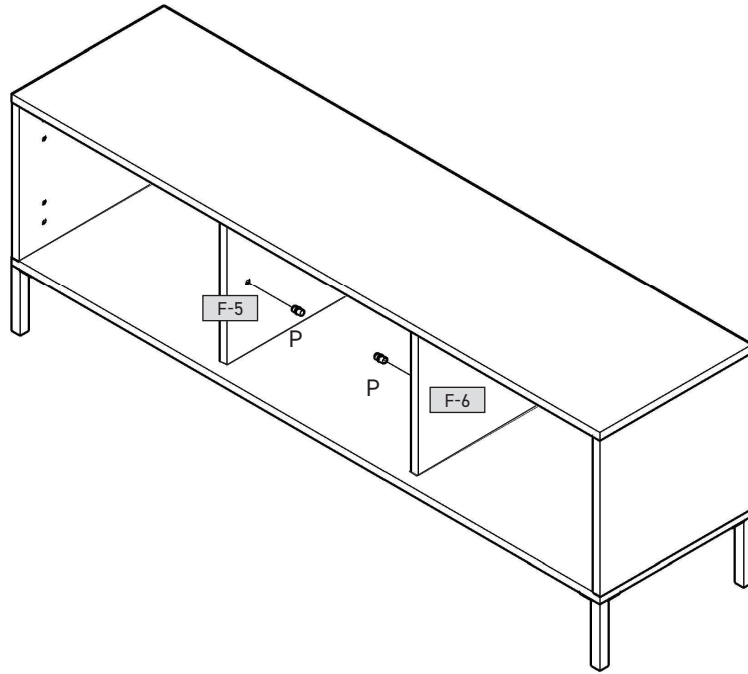
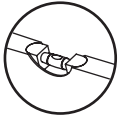
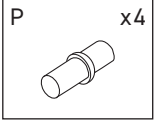

8

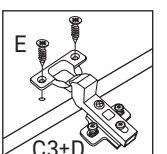
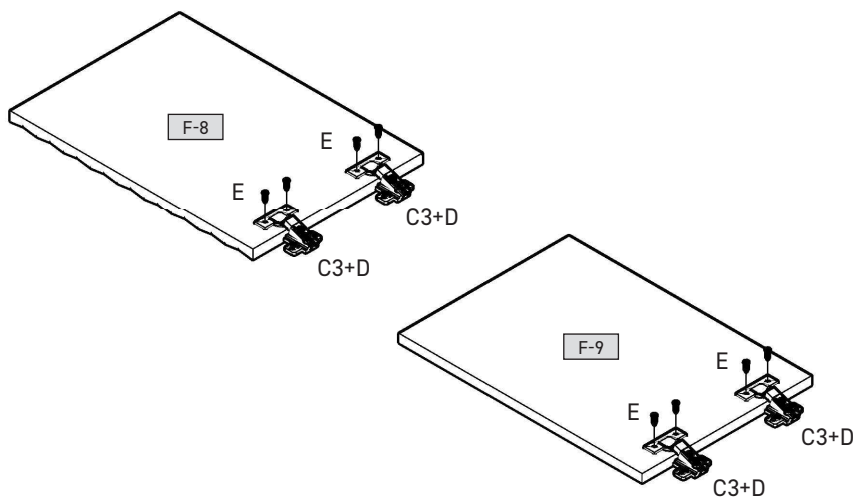
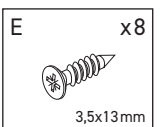
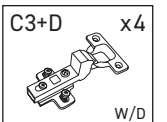

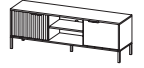

9

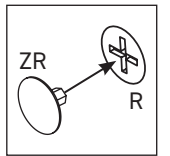
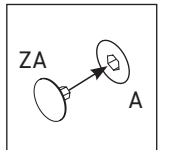
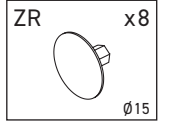
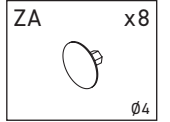
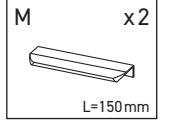
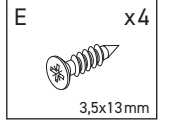
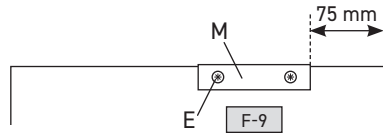
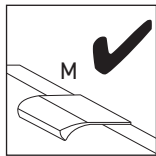
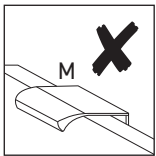
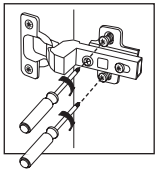
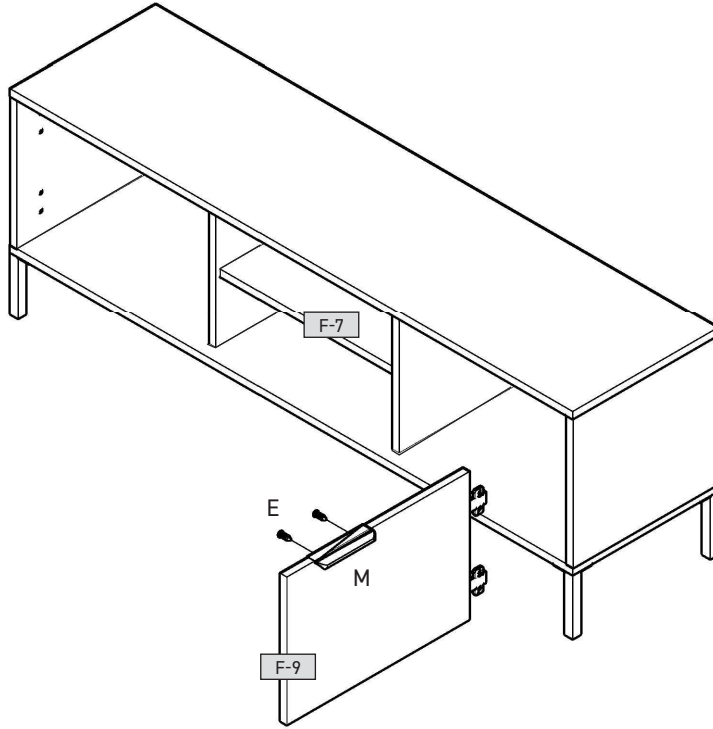
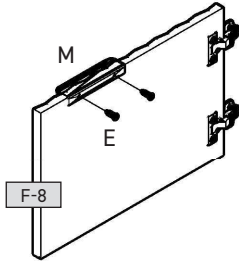
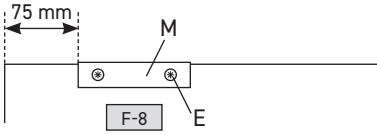

10

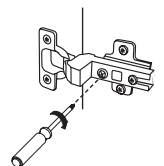
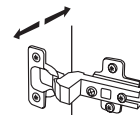
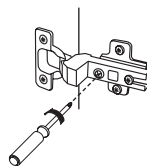
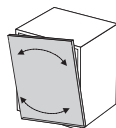
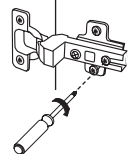
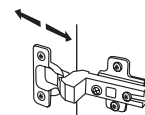
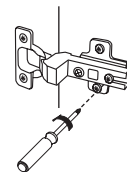
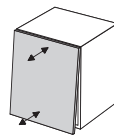
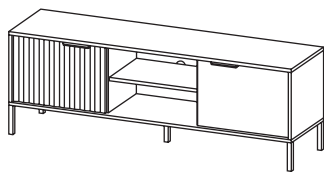
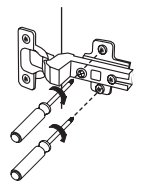
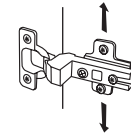
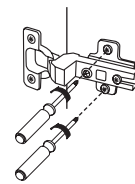
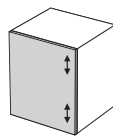



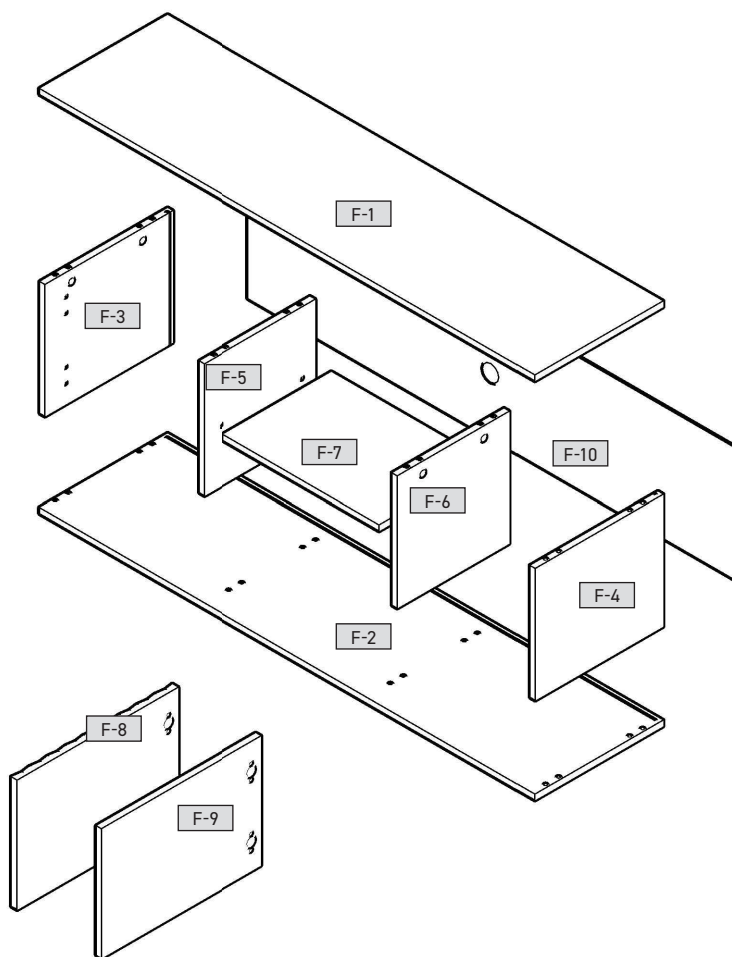
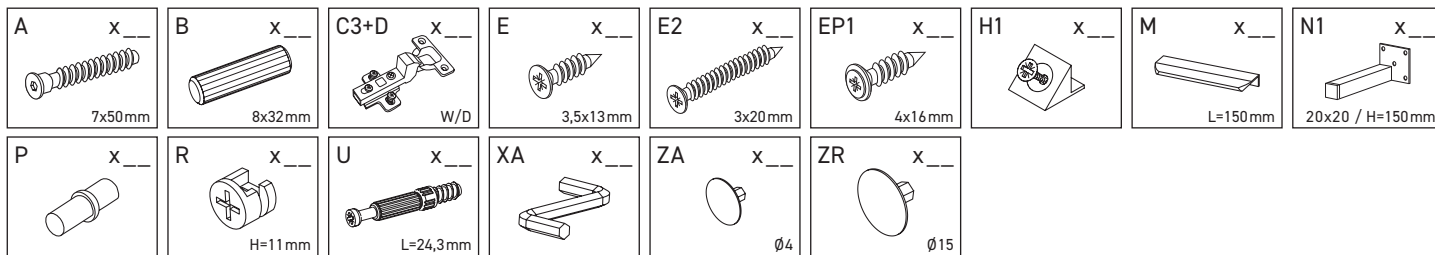

F-1	1531	395	16	x1	1/1
F-2	1531	395	16	x1	1/1
F-3	352	394	16	x1	1/1
F-4	352	394	16	x1	1/1
F-5	352	347	16	x1	1/1
F-6	352	347	16	x1	1/1
F-7	482	335	16	x1	1/1
F-8	496	346	18	x1	1/1
F-9	496	346	16	x1	1/1
F-10	1512	366	3	x1	1/1

